



TN

TAMIL NADU

US

URBAN SANITATION

SP

SUPPORT PROGRAMME

iihsTM
INDIAN INSTITUTE FOR
HUMAN SETTLEMENTS

In Association With:

Keystone
A GROUP FOR RSDI DEVELOPMENT INITIATIVES



CDD Consortium for
DEWATS
Dissemination
Society

Training programme on Fecal Sludge Management for Engineers in Trichy City Corporation

Co-treatment of FS in STP

Introduction

STP at Panjappur

- Capacity of STP
- Inflow
- Headworks and Treatment process
- Headworks and Treatment process – Volume
- What parameters does the STP treat for?



Co-treatment of FS

Septage treatment

- In a stand alone sludge treatment facility
- Co-Treatment



Options??

STP

**Addition to sludge
handling systems**

Municipal Solid Waste

Co-treatment of FS with Sewage

Requirements

- Residual capacity
- FS Characteristics and Volume : higher solids content, BOD , COD etc.

How much septage can be added? Recommended 1%

Trichy's case

- Volume of septage received: 480 m³/d

Approaches for addition: to upstream of sewage or at STP

Decanting station

Infrastructure for decanting station

- Receiving facility: transfer septage from septage trucks.
- Provide screening and grit removal facility

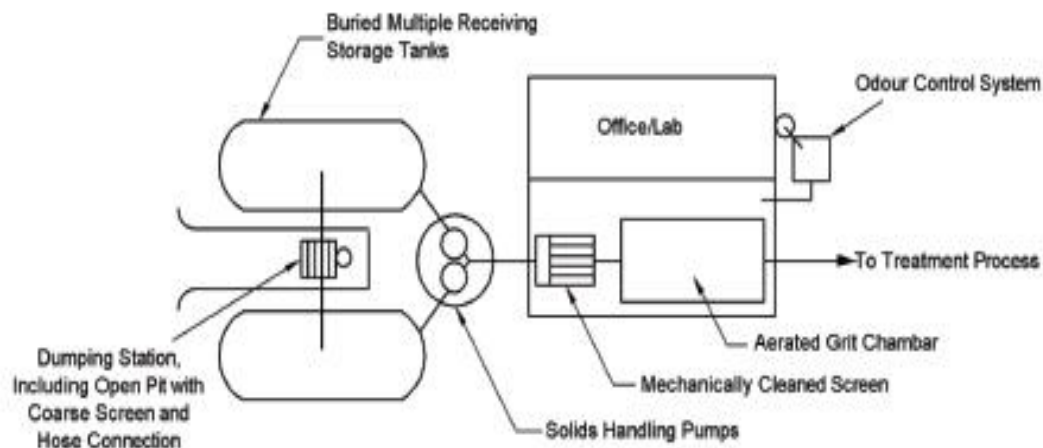

CPHEEO Guidelines

Decanting station- Layout of Anna Stadium

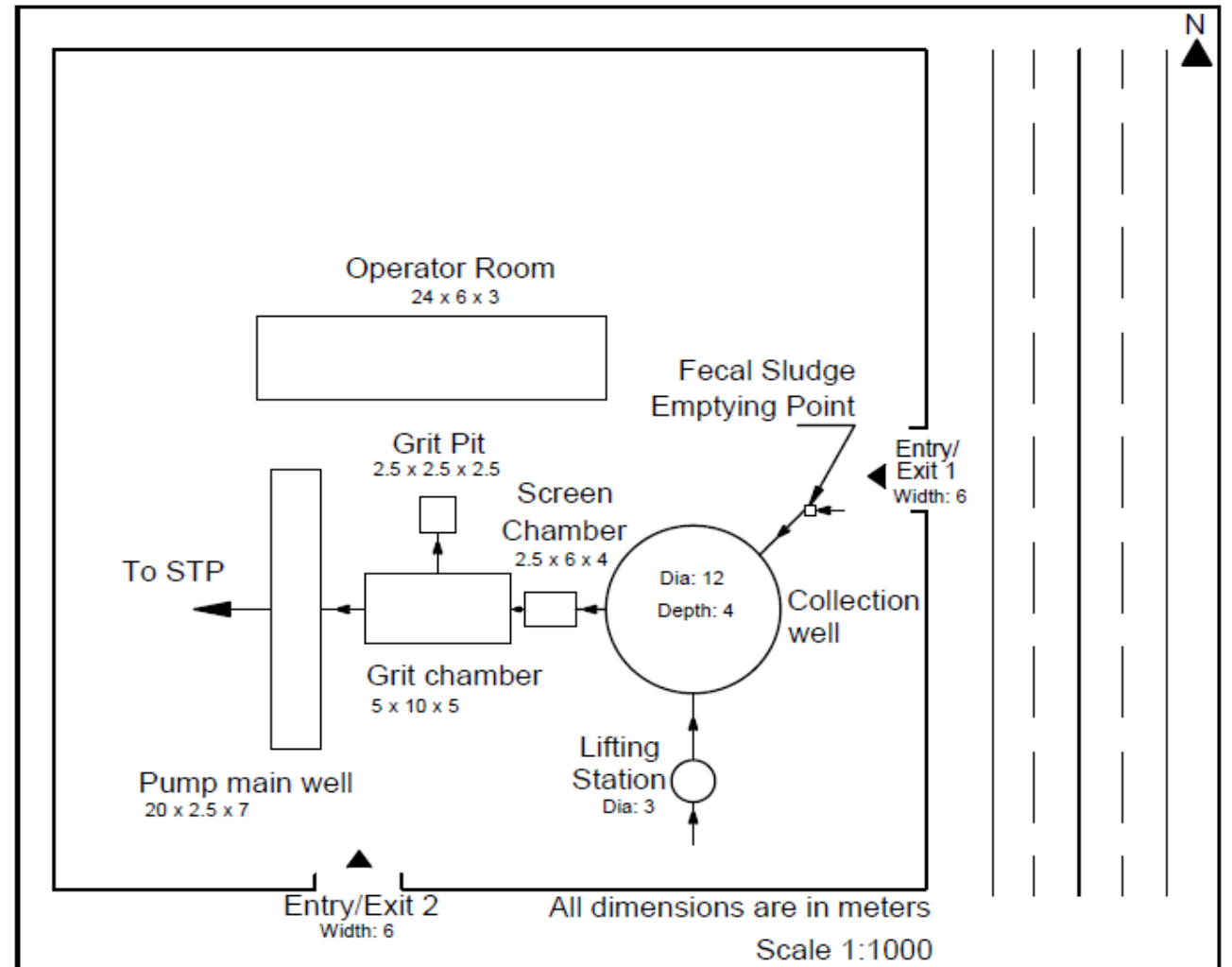

Decanting station

Infrastructure Requirements for a decanting station as per USEPA

1. Dumping station/receiving tank
2. Screening
3. Grit removal
4. Storage or equalisation
5. Odour Control

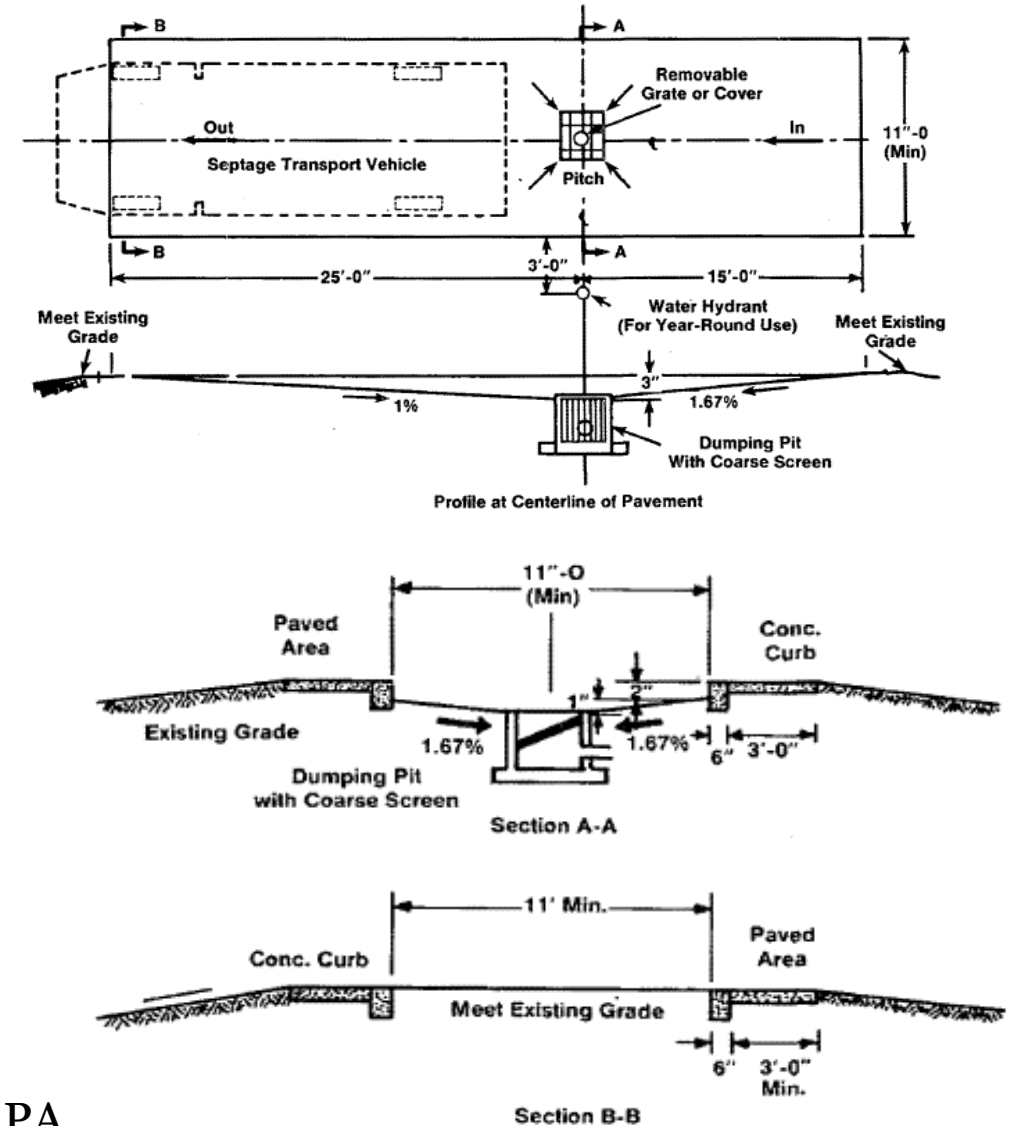

Co-treatment of FS with Sewage

Impacts on STP

- Operational problems
 - Deposition and clogging of sewer pipes
- Disrupt treatment processes – organic loading
- Sludge handling processes– higher solids from FS

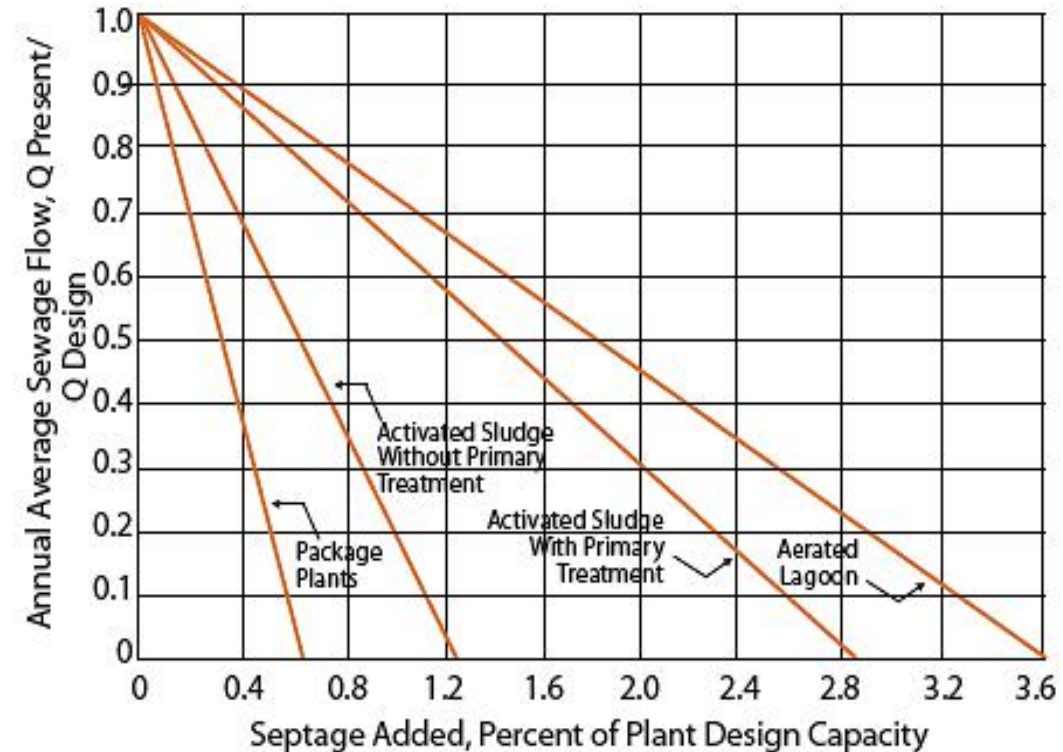

Advantages and disadvantages of co-treatment

Advantages	Disadvantages
STPs are under utilized: Has capacity to handle septage	Poor Performance due to high Solids, BOD
Easy to operate and maintain: Skilled personnel and laboratory facilities are available at STP	Frequency of Screening and grit removal increases

Source: MoUD Advisory on Septage Management

Potential for FS Co-treatment in Tamil Nadu

- GoTN Operative Guidelines for Septage Management for Local Bodies in Tamil Nadu lists **35 cities and towns with operational STPs**
- Installed STP capacity of **1,280 MLD**, average capacity utilization of **~60%**
- 1% FS addition would allow treatment of FS from **~2.8 Lakh HHs*** (or almost **a quarter of the HHs** in these 35 cities)

*Estimated based on assumption on FS quality, emptying frequency etc. Actual numbers will depend on FSM scheme design

S. No.	Name of the Municipality	Nearest Town Panchayats	Panchayat Unions
1	Chennai Corporation (7 No's)	Minjur, Thiruinjavur, Thirumazisai, Naravarikunppam, Thirunearmalai, Chitlapakkam	
2	Chinnamamur	Kuchamur, Markeyankottai	Chinnamamur
3	Coimbatore	Sarkar Samakulam, Vedapatty, Pecur, Vellalur, Irugur	Periyanaickenpalayam, Sarkarsamakulam, Thondamuthur, Suhur
4	Cuddalore	Melpattambakkam	
5	Dharmapuri	Papparpatti	Dharmapuri
6	Dindigul	Thadikombu, Agaram	Dindigul, Athoor, Reddiarchattiram, Shanarpatti, Vedasandur, Vadamadurai
7	Kancheepuram	Walajabad	Kancheepuram, Walajabad, Uthiramerur
8	Karur	Puliyur	Karur, Thanthoni
9	Kumbakonam	Thirunageswaram, Swamimalai, Dharasuram	Kumbakonam
10	Krishnagiri	Cauvery pattinam, Bergur	Saponipatty, Kariyamanangalam, Paiyur, Orappum
11	Madurai	Paravai	Madurai East, Madurai West, Thiruparankundram
12	Maraimalinagar	N.Guduvancherry	Kattankolattur
13	Myladuthurai	Kuthalam, Vaitheeswarankoil	Mayiladuthurai, Kuthalam, Sembanarkoil
14	Mamallapuram	Thiruporur	
15	Namakkal	Sendamangalam	Elaichipalayam, Erumapatti, Mohanur, Namakkal, Puduchattaram, Paramathi, Senthimangalam

Cluster approach closest facility analysis



Feasibility of transport of FS from surrounding urban local bodies

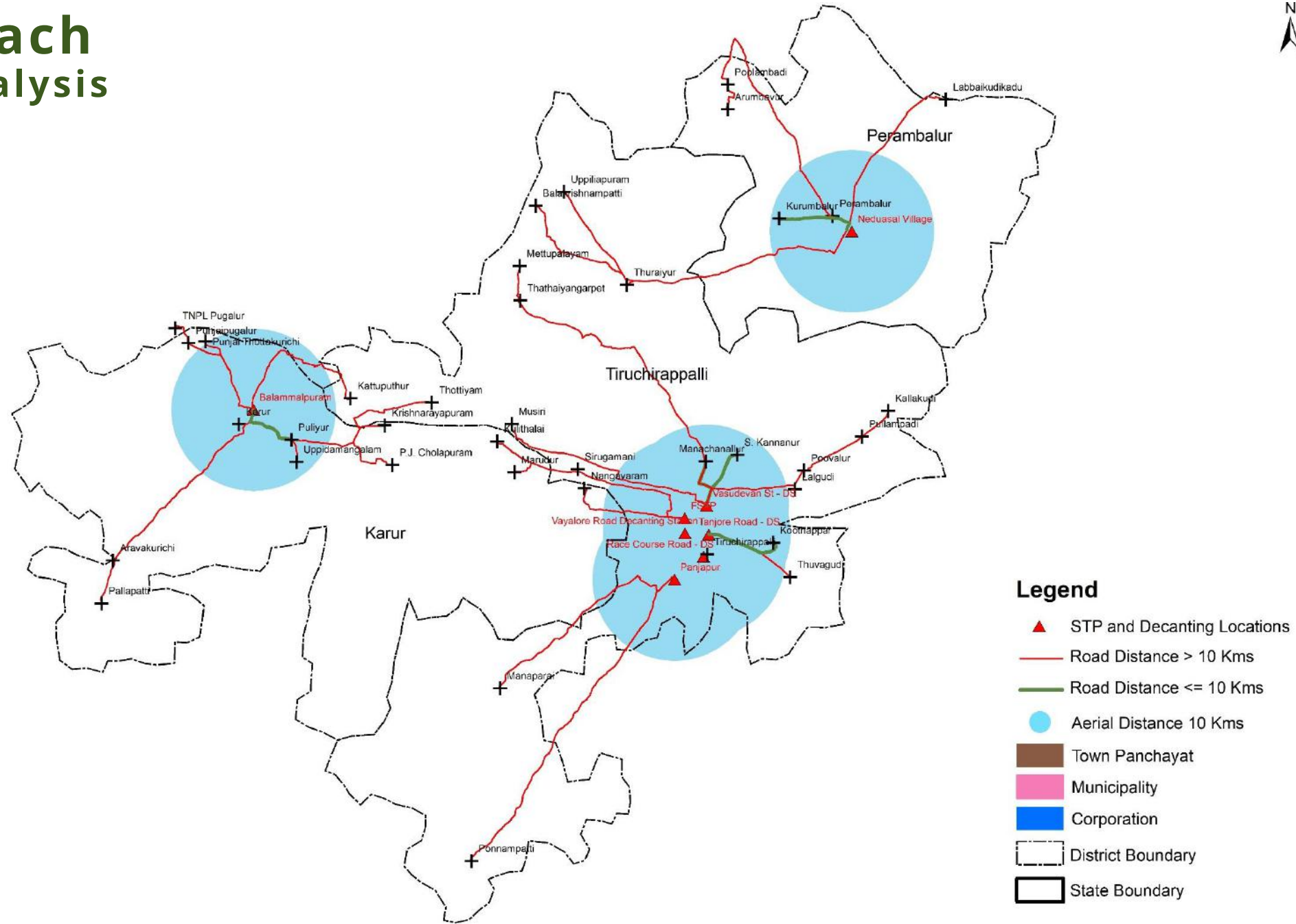

STP

Sl. No.	Description	Value	Unit	Source	
1	Waste stabilization ponds as treatment technology. Effluent discharge to Koraiyar River	Defunct cells	30	MLD	TCC
		Operating cells	58		
2	Current inflow	45	MLD	Field estimation, estimated from pumping stations	
3	No. of Households covered by sewerage network	45000	No.	TCC	
4	Amount of fecal sludge received (Max)	480	m ³ per day	Decanting station survey	

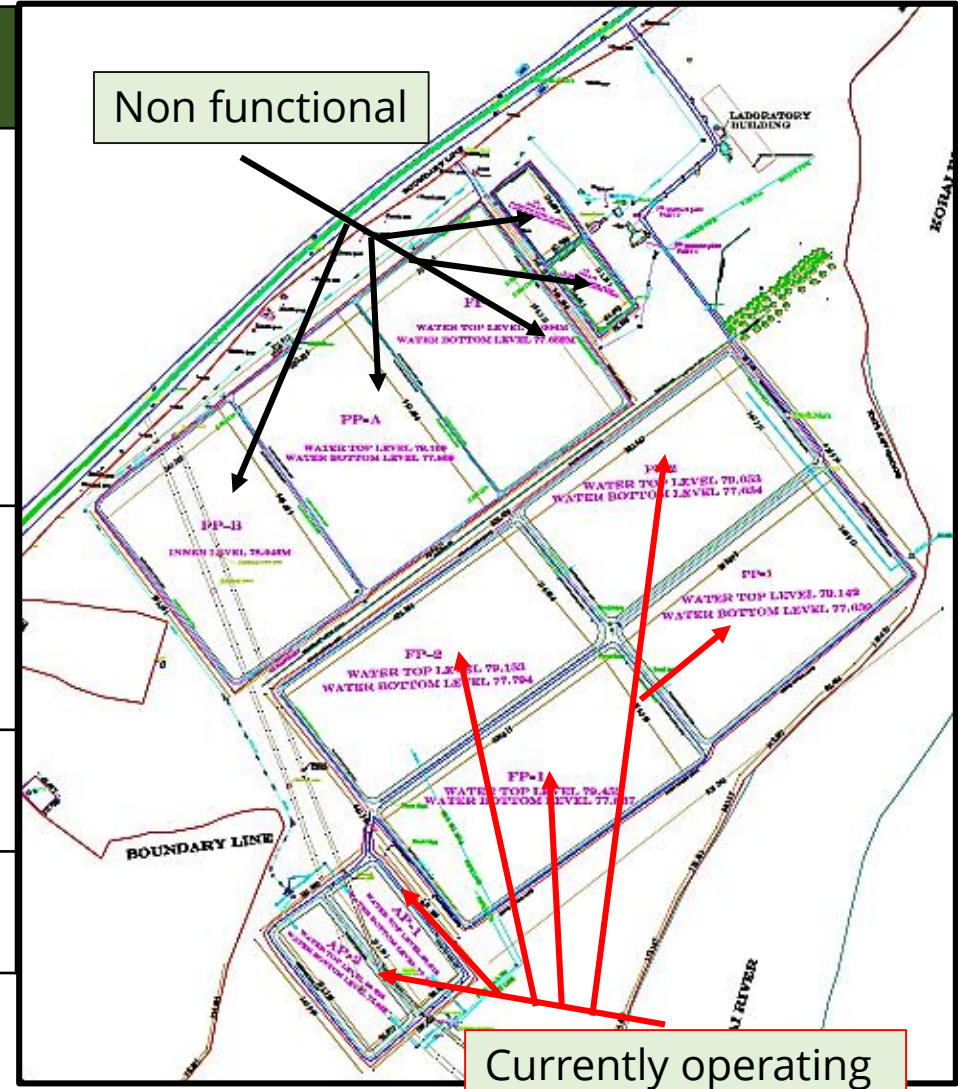

STP

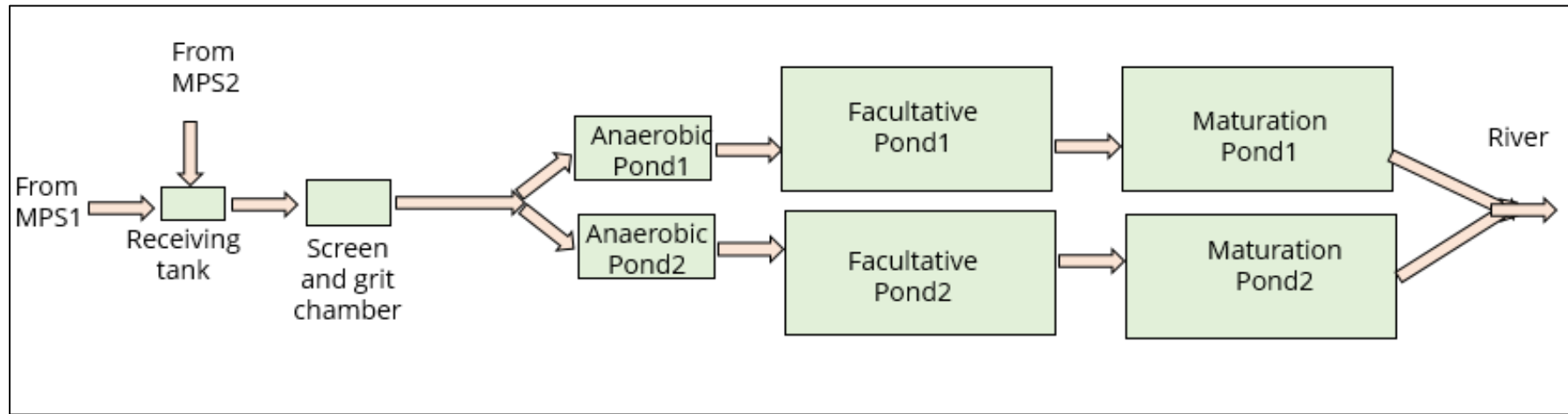

Component	Anaerobic pond1	Anaerobic pond2	Facultative pond1	Facultative pond2	Maturation pond1	Maturation pond2
Volume of water in the pond from survey (m3)*	47,803	50,633	136,938	117,631	115,681	109,030
Calculated Volume (m3)	46,800	46,800	126,688	126,688	110,531	110,531
Useful depth (m) as per TCC report	2.5	2.5	1.5	1.5	1.5	1.5
Water level depth*	2.8	2.8	1.6	1.4	1.5	1.4

*From Survey

Thank You